

## MONTAGEANLEITUNG ASSEMBLING INSTRUCTIONS

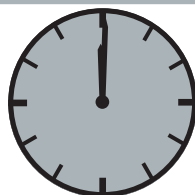

60 Minuten

weight: ca.20,0 kg



**SNOW BROOM HOLDER/SCHNEEBESESTRÄGER**

**- Artikel-Nr: 19R 5650**

**Wild Land Drivers GmbH**  
Sportplatzstr. 4  
D-85635 Höhenkirchen b.München

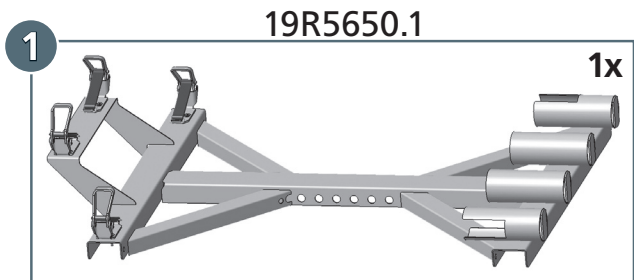
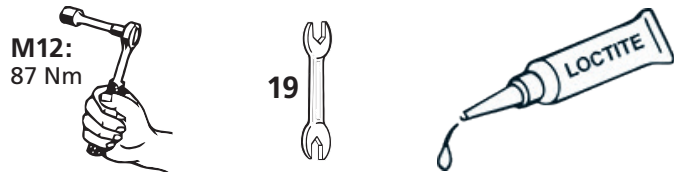
E-Mail: [info@wild-land-drivers.de](mailto:info@wild-land-drivers.de)  
Phone: +49 (0) 8 10 2 / 89 58-16

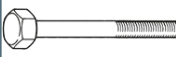

	M12x140; DIN 931 Zn	1x
	Ø12; DIN 127 Zn	1x

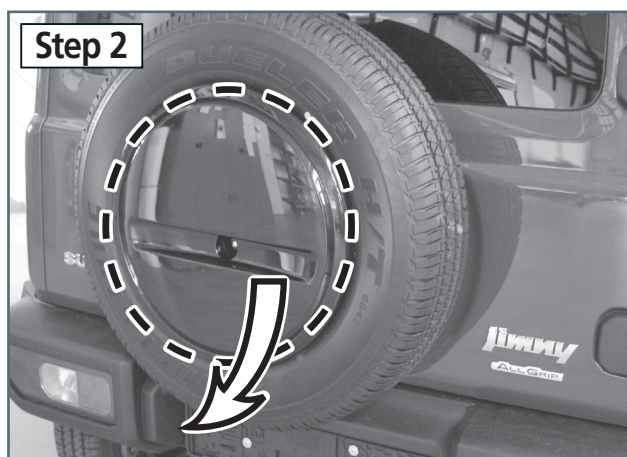
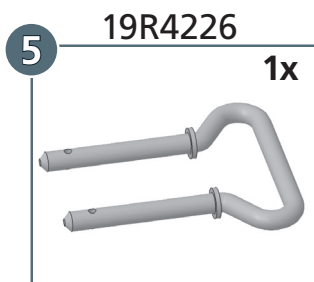
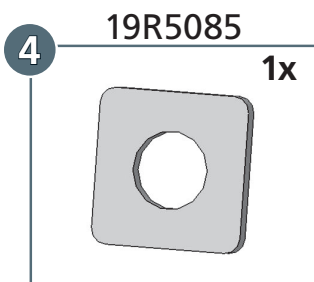
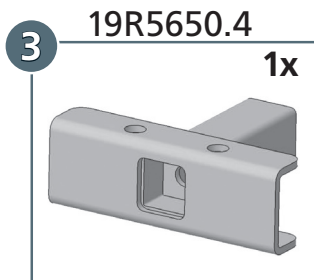
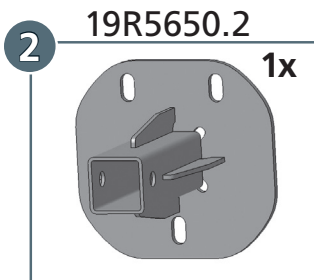

Artikel-Nr:  
19R5650

Revision 3: 05.08.2021



